

Article number: 12317000060100
Description: KLEE-coil 317 000 060.100
M6 Unhardened steel slotted pin

Measures

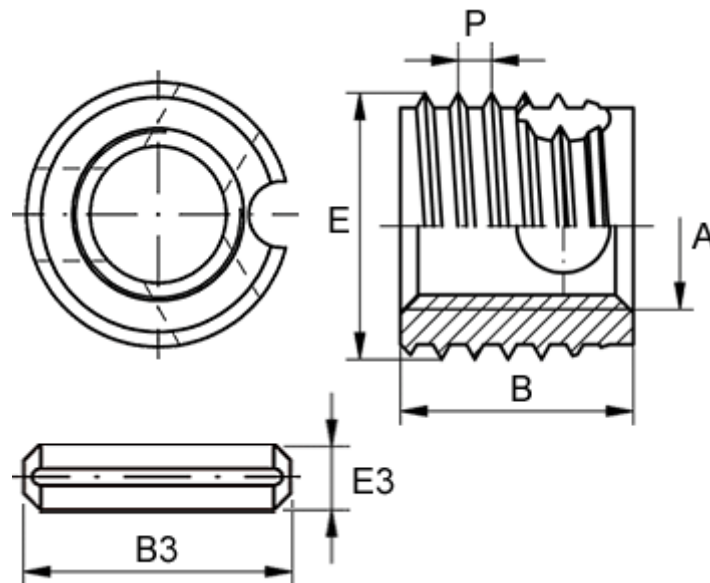

Female thread A	= M6
Length B	= 8
Male thread E	= 10.0
Min hole depth blind hole	= 10
Slotted pin B3	= 6
Slotted pin E3	= 2
Thread pitch P	= 1.25
Type	= 317 000 060 ...